

Behavior of Multiple Supported Secondary System Mounted on a Torsionally Coupled Primary System

Abhijit K. Agrawal¹ and T.K. Datta²

1. Research Scholar, Department of Civil Engineering, IIT Hauz Khas New Delhi, India 110-016
2. Professor, Department of Civil Engineering, IIT Hauz Khas New Delhi, India 110-016, email: tkdatta@civil.iitd.ernet.in

ABSTRACT: *Dynamic behavior of a multiple supported secondary system mounted on a torsionally coupled primary system is presented for bi-directional random ground excitation, which is idealized as a broad band stationary random process. Response behavior of the multiple supported secondary system is investigated by considering and ignoring the interaction between the primary and the secondary systems. The response quantities of interest are the standard deviation of the absolute acceleration at a specified node and the bending moment at a specified support of the multiple supported secondary system. For the no interaction case, input to the support of the secondary system is prescribed in the form of both pseudo and cross power spectral density function (PSDF), characterizing the correlation between various supports of the multiple supported secondary system. For the interaction case, the conventional ground PSDF can directly be used as input to the combined structural system. The responses are obtained by the frequency domain spectral analysis. The responses are obtained under a number of important parametric variations. Numerical results of the study show that the responses decrease with the increase in the mass ratio between the secondary and the primary system. Under the tuned condition, a definite maxima is observed for the higher mass ratio. For strong and weak torsionally coupled primary systems under the tuned and interaction conditions the normalized acceleration show a definite minima when orientation of the secondary system is 45° with the major axes of the primary system. For the other cases, the response quantities show a definite maxima at this orientation.*

Keywords: Primary and secondary systems; Non-classical damping; Torsionally coupled system; Multi-support excitation; Bi-directional excitation

1. Introduction

In many civil and industrial structures, secondary systems (such as piping, fixtures, equipments etc.) are supported on more than one point over the heavy primary system (P-system). Several studies have been made for the evaluation of both deterministic and stochastic responses of composite primary-secondary system (PS-system) [1-5]. The composite characteristics of such systems don't match with usual structures, and traditional methods used for the analysis of classically damped structural systems, are not applicable [6, 7]. Analysis of such structural systems without considering interaction between the primary and the secondary structural systems, is easy and economical [8]. However, this analysis gives incorrect responses of the secondary system (S-system) when the S-system is not very light as

compared to the supporting P-system, and when the frequency of vibration of the S-system matches with one of the dominant frequencies of the supporting structural system. In such situations, responses of the S-system, calculated by considering the interaction between the PS-system give more realistic responses of the S-system [9, 10, 11].

Two methods are generally employed for the analysis of cascaded sub-systems (without considering interaction between the two sub-systems): the cross-floor response spectra method [12, 13], and mean square response method for zero mean Gaussian input [14]. In the first method, the floor response spectra of the primary structural system at the multiple support points of the secondary one, are used as input to the S-system. In the second method, the

response is evaluated for individually classically damped sub-systems, and the response of primary structural system is used as input excitation to the secondary one.

Burdisso and Singh [15] studied response spectrum method for the analysis of the multiple supported secondary structural system using cascaded approach. The earthquake excitations to the P-system were considered in the form of ground response spectra, and the floor spectra of the P-system were taken as input to the S-system. The floor response spectra were defined in the form of auto and cross pseudo-acceleration response spectra. The analysis of multiple supported secondary structural system using the component-mode synthesis approach was presented by Muscolino G. [16]. The main purpose of his study was to write the dynamic equations of motion of the composite systems correctly, and to reduce the modal dynamic equations of motion. Falsone et al [17] also analyzed the combined system using the same approach. Both of them assumed that the S-system is cascaded with the primary structural system.

The studies mentioned before, investigate the effect of different parameters on the responses of the S-system, for the torsionally uncoupled P-system to uni-directional ground excitation. These studies are strictly valid for symmetric buildings or buildings with very small eccentricity or buildings torsionally very stiff. Some investigations on torsionally coupled PS-system are done by Yang and Huang [18, 19]. They found that the torsional coupling of the P-system has significant effect on the response behavior of the S-system under random ground excitation. Recently, Agrawal and Datta [21] studied the behavior of the S-system (a single degree of

freedom system), mounted over torsionally coupled linear P-system. They [22] also studied the behavior of the S-system mounted over torsionally coupled non-linear P-system. In both studies, interaction between the PS- system is considered.

In the present paper, the response behavior of the multiple supported S-system, mounted over the deck of a 3-D torsionally coupled linear P-system, is studied for a bi-directional random ground excitation. Responses are calculated using the frequency domain spectral analysis and by considering and ignoring the interaction between the primary and the secondary systems. The correlated inputs to the multiple points of the S-system, are defined in terms of the power spectral density function (PSDF) and cross PSDF [23]. Objectives of the investigation are:

- i To study the response behavior of the multiple supported S-system under different important parametric variations; and
- ii To investigate the effect of interaction between the PS-system on the behavior of the S-system.

2. System Model

The system model of primary and multiple supported secondary structural system is shown in Figure (1). The P-system is idealized as a 3-D torsionally coupled system. The axial stiffness of both horizontal (beam) and vertical (column) elements of the S-system are assumed to be very high. The normalized eccentricities of the P-system are varied to provide various degrees of torsional coupling in the P-system.

Let K_{pi} ($i = 1,4$) be the lateral stiffness of the

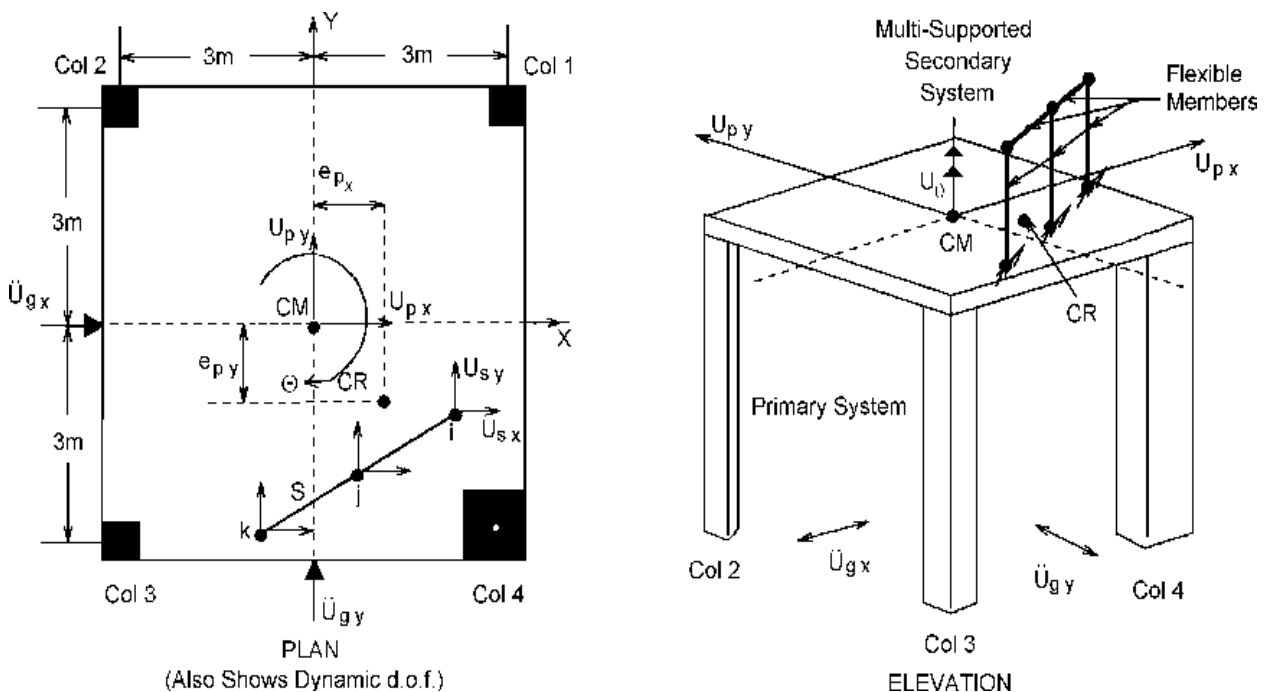

Figure 1. Structural Model.

column of the P-system, then the total stiffness of the P-system in both directions (X and Y) is given by

$$(1)$$

The total stiffness of the S-system in the direction of orientation of S-system is given by K_s , which is the total sum of the lateral stiffness of all the columns of the S-system.

Let r_i denote the distance of the i^{th} resisting element from the center of mass (CM) of the P-system, then the total torsional stiffness of the P-system, defined about the CM , is given by

$$(2)$$

in which it is assumed that the torsional stiffness of the individual column element is negligible. The eccentricities (e_{px} and e_{py}) of the P-system (the distance between the center of resistance (CR) and the CM), in the two orthogonal directions is given by

$$e_{px} = \frac{\sum_{i=1}^4 K_{pi} x_i}{\sum_{i=1}^4 K_{pi}} \quad (3)$$

$$e_{py} = \frac{\sum_{i=1}^4 K_{pi} y_i}{\sum_{i=1}^4 K_{pi}} \quad (4)$$

in which x_i and y_i are the X and Y coordinates of the i^{th} column with respect to the CM of the P-system. Eccentricities of the S-system (e_{sx} and e_{sy}) are taken to be variables for the parametric study. The two uncoupled frequency parameters of the P-system are given by

$$(5)$$

and

$$\omega_{\theta} = \sqrt{\frac{K_{\theta}}{m_p R^2}} \quad (6)$$

and natural frequency of the S-system is given by

$$\omega_s = \sqrt{\frac{K_s}{m_s}} \quad (7)$$

in which m_p and m_s are the masses of the primary and the secondary structural systems respectively, and R is the radius of gyration of the primary mass (distance between center of resistance (CR) and (CM)). The frequencies ω_p and ω_{θ} may be interpreted as the natural

frequencies of the P-system, if they were torsionally uncoupled, i.e. a system with e_{px} and $e_{py} = 0$, but m_p , K_p and K_{θ} are the same as those in the coupled system. The mass ratio ρ is defined as $\rho = \frac{m_p}{m_s}$. The values of K_p and m_p are varied to provide different values of the frequency parameters (ω_p and ω_{θ}) in the analysis. All these parameters are taken to be the same in both X and Y directions.

3. Equations of Motion for the Combined System

The equation of motion for the combined PS-system may be written as

$$[M] \{\ddot{U}\} + [C] \{\dot{U}\} + [K] \{U\} = -[M] [I] \{\ddot{U}_{gj}\} = f(t) \quad (8)$$

where the displacement vector $\{U\}$ is given by $\{U\} = \{U_{px}, U_{py}, U_{\theta}, U_{sx1}, U_{sy1}, U_{sx2}, \dots, U_{syn}\}^T$ and the ground acceleration vector is given by $\{\ddot{U}_{gj}\} = \{\ddot{U}_{gx}, \ddot{U}_{gy}\}^T$. The matrix $[K]$ is calculated by condensing out the rotational $DOFs$ of the S-system from the global stiffness matrix $[\hat{K}]$. The matrix $[\hat{K}]$ is given as

$$[\hat{K}]_{NDF \times NDF} = \begin{bmatrix} [\hat{K}_{11}]_{3 \times 3} & [\hat{K}_{12}]_{3 \times (NDF-3)} \\ [\hat{K}_{21}]_{(NDF-3) \times 3} & [\hat{K}_{22}]_{(NDF-3) \times (NDF-3)} \end{bmatrix} \quad (9)$$

in which the $[\hat{K}_{11}]$ is given as

$$[\hat{K}_{11}] = \begin{bmatrix} \sum K_{pi} + \sum K_k \cos \theta & 0 \\ \sum K_{pi} y_{pi} + \sum K_k \cos \theta y_k & 0 \\ \sum K_{pi} + \sum K_k \sin \theta & \sum K_{pi} y_{pi} + \sum K_k \sin \theta x_k \end{bmatrix} \quad (10)$$

$$\begin{bmatrix} \sum K_{pi} y_{pi} + \sum K_k \cos \theta y_k \\ \sum K_{pi} x_{pi} + \sum K_k \sin \theta x_k \\ K_{\theta} + \sum K_k \cos \theta y_k^2 + \sum K_k \sin \theta x_k^2 \end{bmatrix}$$

the matrix $[\hat{K}_{22}]$ is the submatrix corresponding to the d.o.f of the S-system and the matrix $[\hat{K}_{12}]$ ($= [\hat{K}_{21}]^T$) is the coupling matrix between the primary and the secondary systems. The condensed stiffness matrix $[K]$ is given by

$$[K]_{n \times n} = \begin{bmatrix} [K_{11}]_{3 \times 3} & [K_{12}]_{3 \times (n-3)} \\ [K_{21}]_{(n-3) \times 3} & [K_{22}]_{(n-3) \times (n-3)} \end{bmatrix} \quad (11)$$

in which $n = NDF - NSN$; NDF is number of d.o.f.; and NSN is number of nodes (supports) in the multiple supported S-system.

The influencing coefficient $[I]$, mass $[M]$ and damping $[C]$ matrices are given by

$$[I]_{2 \times n} = \begin{bmatrix} 1 & 0 & 1 & 0 & \dots & \dots \\ 0 & 1 & 0 & 1 & \dots & \dots \end{bmatrix}^T \quad (12)$$

$$[M]_{n \times n} = \begin{bmatrix} [M_{11}]_{3 \times 3} & [0] \\ [0] & [M_{22}]_{(n-3) \times (n-3)} \end{bmatrix} \quad (13)$$

$$[C]_{n \times n} = \begin{bmatrix} [C_{11}]_{3 \times 3} & [0] \\ [0] & [C_{22}]_{(n-3) \times (n-3)} \end{bmatrix} \quad (14)$$

where $[M_{11}]$ and $[M_{22}]$ are given as

$$[M_{11}] = \text{diag} [m_p, m_p, m_p R^2] \quad (15)$$

$$[M_{22}] = \text{diag} [m_s, m_s, m_s, \dots] \quad (16)$$

The elements of the matrices $[C_{11}]$ and $[C_{22}]$ are calculated by assuming that the damping matrix of the P-system (for $[C_{11}]$) and the S-system (for $[C_{22}]$), are proportional to their mass ($[M_{11}]$ and $[M_{22}]$) and stiffness ($[K_{11}]$ and $[K_{22}]$) matrices. Using the modal damping ratio and first two undamped mode shapes of the primary and the secondary structural systems, the elements of the damping matrices $[C]$ ($[C_{11}]$ and $[C_{22}]$) are obtained by standard procedure [24].

4. Equation of Motion for Cascaded System

The equation for the P-system (only) to random ground excitation is given by

$$[M_p] \{\ddot{U}_p\} + [C_p] \{\dot{U}_p\} + [K_p] \{U_p\} = -[M_p][I_p] \{\ddot{U}_{gj}\} = f_p(t) \quad (17)$$

the vector $\{U_p\}$ is given as $\{U_p\} = \{U_{px}, U_{py}, U_{\theta}\}$,

and the matrices $[I_p]$, $[M_p]$, $[C_p]$ are given as

$$[I_p] = \begin{bmatrix} 1 & 0 & 0 \\ 0 & 1 & 0 \end{bmatrix}^T \quad (18)$$

$$[M_p] = \text{diag} [m_p, m_p, m_p R^2] \quad (19)$$

$$[C_p] = \begin{bmatrix} \sum C_{pi} & 0 & \sum C_{px\theta} \\ 0 & \sum C_{pi} & \sum C_{py\theta} \\ \sum C_{\theta px} & \sum C_{\theta py} & C_{\theta} \end{bmatrix} \quad (20)$$

and

$$[K_p] = \begin{bmatrix} \sum K_{pi} & 0 & \sum K_{pi} y_i \\ 0 & \sum K_{pi} & \sum K_{pi} x_i \\ \sum K_{pi} y_i & \sum K_{pi} x_i & \sum K_{pi} (x_i^2 + y_i^2) \end{bmatrix} \quad (21)$$

where C_{pi} , $\sum C_{px\theta}$ ($= \sum C_{\theta px}$), C_{θ} are the elements of the damping matrix for the P-system and $i = 1, 2, 3, 4$. These elements are calculated in the same manner as described for the interaction case.

The equation of motion for the multiple supported S-system, for no-interaction case is given as

$$[M_s] \{\ddot{U}_s\} + [C_s] \{\dot{U}_s\} + [K_s] \{U_s\} = -[M_s][I_s] \{\ddot{U}_p\} = f_s(t) \quad (22)$$

where the matrices $[M_s]$, $[C_s]$ and $[K_s]$ are the mass, damping and stiffness matrices for the S-system, and are represented by $[M_s] = [M_{22}]$ (Eq. (13)); $[C_s] = [C_{22}]$ (Eq. (14)); and $[K_s] = [K_{22}]$ (Eq. (11)). The displacement vector $\{U_s\}$ is given by $\{U_s\} = \{U_{sx1}, U_{sy1}, U_{sx2}, U_{sy2}, \dots, U_{syn}\}^T$. The resultant of the input floor acceleration vector $\{\ddot{U}_p\}$ at various supports of the S-system is given by

$$\{\ddot{U}_p\}_{NSN \times 1} = \{\ddot{U}_{p1}, \ddot{U}_{p2}, \ddot{U}_{p3}, \dots\}^T \quad (23)$$

The equation of motion for a multiple supported structural system, which is subjected to random ground excitation is given as [25]

$$[[M_s] [M_g]] \begin{Bmatrix} \{\ddot{U}_{sj}\} \\ \{\ddot{U}_p\} \end{Bmatrix} + [[C_s] [C_g]] \begin{Bmatrix} \{\dot{U}_{sj}\} \\ \{\dot{U}_p\} \end{Bmatrix} + [[K_s] [K_g]] \begin{Bmatrix} \{U_{sj}\} \\ \{U_p\} \end{Bmatrix} = 0.0 \quad (24)$$

in which the motion vectors have been partitioned to separate the response quantities from the input, and the property matrices have been partitioned to correspond. The coupling matrices that express force in the response degrees of freedom due to motion of the support are denoted here with the subscript g . From Eq. (24), the correlation matrix $[r_s]$ can be expressed as

$$[r_s] = -[K_s]^{-1} [K_g] \quad (25)$$

Solving Eq. (24) and transferring all terms associated with the input to the right side of the equation, the following equation is obtained

$$[M_s] \{\ddot{U}_{sj}\} + [C_s] \{\dot{U}_{sj}\} + [K_s] \{U_{sj}\} = -([M_s][r_s] + [M_g])[I_s] \{\ddot{U}_p\} - ([C_s][r_s] + [C_g]) \{\dot{U}_p\} \quad (26)$$

From Eq. (26), it will be noted that there is no stiffness term in the right side of the expression; it drops out because of the definition of the quasi-static displacement

matrix given by Eq. (25). Also, this relationship will eliminate any effective input associated with a stiffness proportional component of the viscous damping. Consequently, Eq. (26) may be written in the approximate form as

$$[M_s]\{\ddot{U}_{sj}\} + [C_s]\{\dot{U}_{sj}\} + [K_s]\{U_{sj}\} = -([M_s][r_s] + [M_g])[I_s]\{\ddot{U}_p\} \quad (27)$$

The above equation (Eq. (27)), can effectively be used for calculation of responses of the multiple supported S-system.

5. Response Analysis

5.1. Combined PS-System

The frequency response function matrix $H(\omega)$ for the combined system is given by

$$H(\omega) = (-\omega^2[M] + i\omega[C] + [K])^{-1} \quad (28)$$

If $S_{\ddot{U}_{gj}}$ is the power spectral density function (PSDF) of the input excitation, which is modelled as a stationary random process, then the PSDF matrix of the displacement is given by

$$S_{U_j}(\omega) = H(\omega)S_f(\omega)H(\omega)^{*T} \quad (29)$$

where $S_f(\omega)$ is the PSDF matrix of $f(t)$ and it is given by

$$[S_f(\omega)]_{n \times n} = \begin{bmatrix} [S_{11}]_{3 \times 3} & [S_{12}]_{3 \times (n-3)} \\ [S_{21}]_{(n-3) \times 3} & [S_{22}]_{(n-3) \times (n-3)} \end{bmatrix} S_{\ddot{U}_g}(\omega) \quad (30)$$

the various elements of the $[S_f(\omega)]$ matrix is given as

$$[S_{11}] = \text{diag} \left[m_p^2(S_{\ddot{U}_{gx}}), m_p^2(S_{\ddot{U}_{gy}}), 0 \right] \quad (31)$$

$$[S_{12}] = \begin{bmatrix} m_p m_s(S_{\ddot{U}_{gx}}) & 0 & 0 & \dots \\ 0 & m_p m_s(S_{\ddot{U}_{gy}}) & 0 & \dots \\ 0 & 0 & 0 & \dots \end{bmatrix} \quad (32)$$

$$[S_{21}] = [S_{12}]^T \quad (33)$$

$$[S_{22}] = \text{diag} [m_s^2(S_{\ddot{U}_{gx}}), m_s^2(S_{\ddot{U}_{gy}}), \dots, m_s^2(S_{\ddot{U}_{gy}})] \quad (34)$$

The relative displacement U_{rjk} and absolute acceleration \ddot{U}_{ajk} (for k^{th} support of the S-system whose coordinates are (x_k, y_k) , obtained as ($j = X, Y$)

$$U_{rxk} = U_{sxx} - U_{px} - U_{\theta} y_k \quad (35)$$

$$(36)$$

and

$$\ddot{U}_{ajk} = \ddot{U}_{sjk} + \ddot{U}_{gi} \quad (37)$$

The PSDFs of the relative displacements and absolute accelerations ($S_{U_{rxk}}, S_{U_{ryk}}$ and $S_{\ddot{U}_{ajk}} \dots j = X, Y$) are given by

$$S_{U_{rxk}} = \quad (38)$$

$$S_{U_{px}} + y_k^2 S_{U_{\theta}} + S_{U_{sxx}} + y_k S_{U_{px}U_{\theta}} + y_k S_{U_{\theta}U_{px}} - S_{U_{px}U_{sxx}} - S_{U_{sxx}U_{px}} - y_k S_{U_{sxx}U_{\theta}} - y_k S_{U_{\theta}U_{sxx}}$$

$$S_{U_{ryk}} = \quad (39)$$

$$S_{U_{py}} + x_k^2 S_{U_{\theta}} + S_{U_{syk}} + x_k S_{U_{py}U_{\theta}} + x_k S_{U_{\theta}U_{py}} - S_{U_{py}U_{syk}} - S_{U_{syk}U_{py}} - x_k S_{U_{syk}U_{\theta}} - x_k S_{U_{\theta}U_{syk}}$$

and

$$S_{\ddot{U}_{ajk}} = S_{\ddot{U}_{sjk}} + S_{\ddot{U}_{gj}} + S_{\ddot{U}_{gj}U_{sjk}} + S_{\ddot{U}_{sjk}U_{gj}} \quad (40)$$

The elements of the right hand side (RHS) of the Eqs. (38) and (39) can directly be obtained from the PSDF matrix of the displacement of the combined structural system. The elements of the RHS of Eq. (40) are derived as

$$S_{\ddot{U}_{sjk}} = \omega^4 S_{U_{sjk}} \quad (41)$$

$$S_{\ddot{U}_{sxl}U_{gx}} = H(6,1)S_{\ddot{U}_{gx}} \quad (42)$$

$$S_{\ddot{U}_{syl}U_{gy}} = H(7,2)S_{\ddot{U}_{gy}} \quad (43)$$

$$S_{\ddot{U}_{gx}U_{sxl}} = H(6,1)*S_{\ddot{U}_{gx}} \quad (44)$$

$$S_{\ddot{U}_{gy}U_{syl}} = H(7,2)*S_{\ddot{U}_{gy}} \quad (45)$$

where $H(6,1)$ and $H(7,2)$ are the elements of the $H(\omega)$ matrix for the first support of the multiple supported S-system. The elements of Eq. (40) for the other supports of the S-system are calculated in a similar manner. The variances of the response quantities (bending moment ($\sigma_{U_M}^2$) at first support of the S-system and absolute acceleration ($\sigma_{\ddot{U}_a}^2$) of the first node of the S-system are obtained as

$$\sigma_{U_M}^2 = \int_{-\infty}^{+\infty} S_{U_M}(\omega) d\omega \quad (46)$$

$$\sigma_{\ddot{U}_a}^2 = \int_{-\infty}^{+\infty} S_{\ddot{U}_a}(\omega) d\omega \quad (47)$$

where $S_{U_M}(\omega)$ is calculated with help of power spectral density function of relative displacement and rotation at the first node and the cross power spectral density

function between them.

5.2. Cascaded System

The frequency response function matrix $H_p(\omega)$, for the P-system, for the cascaded system is given by

$$H_p(\omega) = (-\omega^2[M_{11}] + i\omega[C_{11}] + [K_{11}])^{-1} \quad (48)$$

where the matrices $[M_{11}]$, $[C_{11}]$ and $[K_{11}]$ are given by Eqs. (15, 14 and 11, respectively). The *PSDF* of the input to the S-system is given as

$$[S_{f_s}(\omega)]_{3 \times 3} = \begin{bmatrix} S_{\ddot{u}_{k\alpha}\ddot{u}_{k\alpha}} & S_{\ddot{u}_{l\alpha}\ddot{u}_{k\alpha}} & S_{\ddot{u}_{m\alpha}\ddot{u}_{k\alpha}} \\ S_{\ddot{u}_{k\alpha}\ddot{u}_{l\alpha}} & S_{\ddot{u}_{l\alpha}\ddot{u}_{l\alpha}} & S_{\ddot{u}_{m\alpha}\ddot{u}_{l\alpha}} \\ S_{\ddot{u}_{k\alpha}\ddot{u}_{m\alpha}} & S_{\ddot{u}_{l\alpha}\ddot{u}_{m\alpha}} & S_{\ddot{u}_{m\alpha}\ddot{u}_{m\alpha}} \end{bmatrix} \quad (49)$$

where k, l and m are the support points of the S-system. The elements of the $[S_{f_s}(\omega)]$ matrix are given as

$$S_{\ddot{u}_{k\alpha}\ddot{u}_{k\alpha}} = \{T_k\} \{\bar{S}\} \{T_k\}^T \quad (50)$$

$$S_{\ddot{u}_{k\alpha}\ddot{u}_{l\alpha}} = \{T_k\} \{\bar{S}\} \{T_l\}^T \quad (51)$$

etc.

where k and l are any two support points of the S-system.

The vectors $\{T_k\}$, $\{T_l\}$ etc. are given as

$$\{T_k\} = \{\cos \alpha, \cos \alpha, \sin \alpha, \sin \alpha, (y_k \cos \alpha + x_k \sin \alpha)\} \quad (52)$$

$$\{T_l\} = \{\cos \alpha, \cos \alpha, \sin \alpha, \sin \alpha, (y_l \cos \alpha + x_l \sin \alpha)\} \quad (53)$$

and the $[\bar{S}]$ matrix is given by

$$[\bar{S}]_{5 \times 5} = \begin{bmatrix} S_{\ddot{u}_{px}\ddot{u}_{px}} & S_{\ddot{u}_{gx}\ddot{u}_{px}} & S_{\ddot{u}_{py}\ddot{u}_{px}} & S_{\ddot{u}_{gy}\ddot{u}_{px}} & S_{\ddot{u}_{\theta}\ddot{u}_{px}} \\ S_{\ddot{u}_{px}\ddot{u}_{gx}} & S_{\ddot{u}_{gx}\ddot{u}_{gx}} & S_{\ddot{u}_{py}\ddot{u}_{gx}} & S_{\ddot{u}_{gy}\ddot{u}_{gx}} & S_{\ddot{u}_{\theta}\ddot{u}_{gx}} \\ S_{\ddot{u}_{px}\ddot{u}_{py}} & S_{\ddot{u}_{gx}\ddot{u}_{py}} & S_{\ddot{u}_{py}\ddot{u}_{py}} & S_{\ddot{u}_{gy}\ddot{u}_{py}} & S_{\ddot{u}_{\theta}\ddot{u}_{py}} \\ S_{\ddot{u}_{px}\ddot{u}_{gy}} & S_{\ddot{u}_{gx}\ddot{u}_{gy}} & S_{\ddot{u}_{py}\ddot{u}_{gy}} & S_{\ddot{u}_{gy}\ddot{u}_{gy}} & S_{\ddot{u}_{\theta}\ddot{u}_{gy}} \\ S_{\ddot{u}_{px}\ddot{u}_{\theta}} & S_{\ddot{u}_{gx}\ddot{u}_{\theta}} & S_{\ddot{u}_{py}\ddot{u}_{\theta}} & S_{\ddot{u}_{gy}\ddot{u}_{\theta}} & S_{\ddot{u}_{\theta}\ddot{u}_{\theta}} \end{bmatrix} \quad (54)$$

The elements of the $[\bar{S}]$ matrix are derived from the following basic equation

$$\begin{Bmatrix} U_{px} \\ U_{py} \\ U_{\theta} \end{Bmatrix}_{3 \times 1} = [H_p(\omega)]_{3 \times 3} \begin{Bmatrix} \ddot{U}_{gx} \\ \ddot{U}_{gy} \\ 0 \end{Bmatrix}_{3 \times 1} \quad (55)$$

The frequency response function matrix for the S-system $H_s(\omega)$, is given by

$$H_s(\omega) = (-\omega^2[M_{22}] + i\omega[C_{22}] + [K_{22}])^{-1} \quad (56)$$

where, the matrices $[M_{22}]$, $[C_{22}]$ and $[K_{22}]$ are given by Eqs. (16, 14 and 11, respectively). The *PSDF* of the displacement between the P-system and a specified support of the S-system is given by

$$S_{U_s}(\omega) = H_s(\omega) S_{f_s}(\omega) H_s(\omega)^{*T} \quad (57)$$

and the *PSDF* of the absolute acceleration $S_{\ddot{u}_{as}}$ (for the specified support of the S-system) is obtained as

$$S_{\ddot{u}_{as}} = S_{\ddot{u}_a} + S_{\ddot{u}_s} + S_{\ddot{u}_a\ddot{u}_s} + S_{\ddot{u}_s\ddot{u}_a} \quad (58)$$

where $(S_{\ddot{u}_a})$ is the *PSDF* of the resultant of the floor motion in the two orthogonal directions. The elements of the *RHS* of Eq. (58) are obtained by the procedure described previously. The variance of response quantities of interest for the cascaded system are obtained as

$$\sigma_{U_{Ms}}^2 = \int_{-\infty}^{+\infty} S_{U_{Ms}}(\omega) d\omega \quad (59)$$

$$\sigma_{\ddot{u}_{as}}^2 = \int_{-\infty}^{+\infty} S_{\ddot{u}_{as}}(\omega) d\omega \quad (60)$$

where $S_{U_{Ms}}(\omega)$ is calculated in the same manner as described for the interaction case.

6. Parametric Study

A large number of parameters influence the responses “*RMS*” value of the normalized absolute acceleration ($\sigma_{\ddot{x}_a}/g = \sigma_{\ddot{u}_a}/g$ or $\sigma_{\ddot{u}_{as}}/g$) at a specified node, and the *RMS* value of bending moment ($\sigma_M = \sigma_{U_M}$ or $\sigma_{U_{Ms}}$) at a specified support of the multi-supported S-system. The important parameters, which predominantly influence the behavior of the PS-system, are considered in the present study. These parameters include the normalized eccentricities of the P-system (e_{px}/R and e_{py}/R) in the two orthogonal directions (X and Y); the uncoupled lateral frequencies of the P-system (ω_p) and the S-system; the damping ratios of the P-system (ξ_p) and the S-system; the ratio of uncoupled lateral to rotational frequencies (ω_p/ω_{θ}) of the P-system; and the mass ratio m_s/m_p of the PS-system. Values of the other parameters (held constant throughout) are $\omega_p = 3.0 \text{ rad/sec}$, $\xi_p = 5.0\%$, $\xi_s = 2.0\%$ and $R = 3.0$ meters. Intensity of the white noise input excitation is the same in both X and Y directions, and is taken as $0.013 \text{ m}^2/\text{sec/rad}$. The time history of ground acceleration is simulated from the *PSDF* of white noise for a record length of 200 seconds. The coordinates of the supports, see Figure (1), of the S-system are $(-0.5, -2.2)$, $(0.5, -1.8)$ and $(1.5, -1.4)$. The plan area of the primary structural model is $6.0 \text{ m} \times 6.0 \text{ m}$. The absolute acceleration at the top node of the first support $(-0.5, -2.2)$, and the *RMS* value of the bending moment at its base are taken as response quantities of interest for the analysis.

6.1. Effect of e_{px}/R and e_{py}/R

Figures (2) to (5) show the variations of responses with normalized eccentricities (e_{px}/R and e_{py}/R) of the P-system. Both interaction and no-interaction cases are studied for strong ($\omega_p/\omega_\theta = 1.0$) and weak ($\omega_p/\omega_\theta = 0.5$)

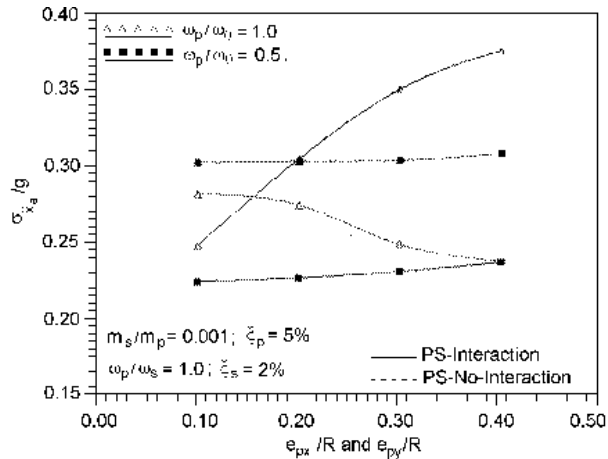

Figure 2. Variation of (σ_{x_a}/g) with e_{px}/R and e_{py}/R for $\omega_p/\omega_\theta = 1.0$.

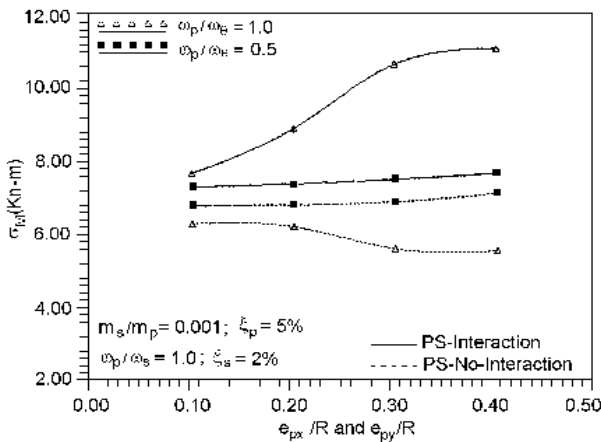

Figure 3. Variation of (σ_M) with e_{px}/R and e_{py}/R for $\omega_p/\omega_\theta = 1.0$.

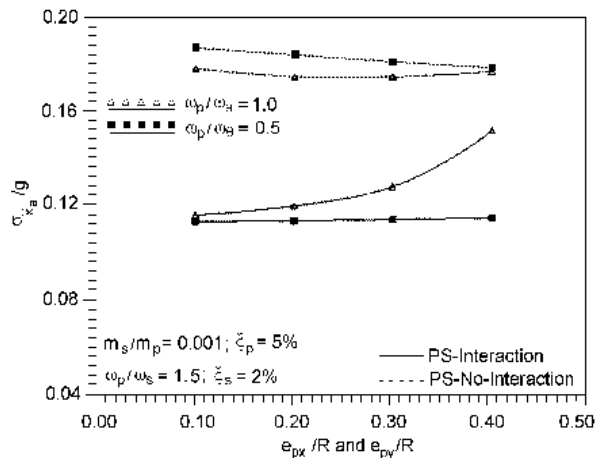

Figure 4. Variation of (σ_{x_a}/g) with e_{px}/R and e_{py}/R for $\omega_p/\omega_s = 1.5$.

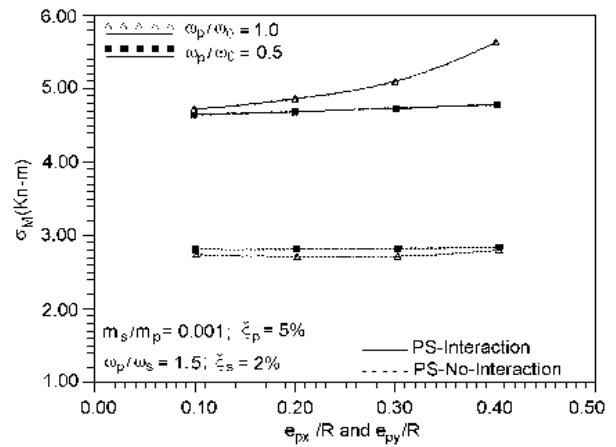

Figure 5. Variation of (σ_M) with e_{px}/R and e_{py}/R for $\omega_p/\omega_s = 1.5$.

torsionally coupled P-system under tuned ($\omega_p/\omega_s = 1.0$) and untuned ($\omega_p/\omega_s = 1.5$) conditions. For the weak torsionally coupled P-system, the variations are the same for both interaction and no-interaction cases. Further, the responses are almost insensitive to the variation of e_{px}/R and e_{py}/R . The acceleration response is more, while the bending moment response is less for the no-interaction case. The response behavior is the same for both tuned and untuned conditions.

For strong torsionally coupled P-system under both tuned and untuned conditions, the responses increase with the increase in e_{px}/R and e_{py}/R , if interaction is considered between the PS-system. However, the responses decrease with the increase in e_{px}/R and e_{py}/R under the tuned condition and remain insensitive to the variation of e_{px}/R and e_{py}/R under the untuned condition, if interaction is not considered between the PS-system.

6.2. Effect of Primary-Secondary Interaction

Figures (2) to (5) and Figures (8) to (13) show the effect of primary-secondary interaction on the responses. For strong and weak torsionally coupled P-system under the tuned condition interaction between the PS-system (PS-interaction) provides higher (σ_M) for all angle of orientations. However, an opposite pattern of variation in (σ_M) is observed under the untuned condition. For both strong and weak torsionally coupled P-system under the untuned condition (σ_{x_a}/g) is found to be less if interaction is considered between the PS-system. Such behavior is also observed for weak torsionally coupled P-system under the tuned condition.

6.3. Effect of the Ratio

Figures (6) and (7) show the effect of the mass ratio on the (σ_{x_a}/g). For weak torsionally coupled P-system under

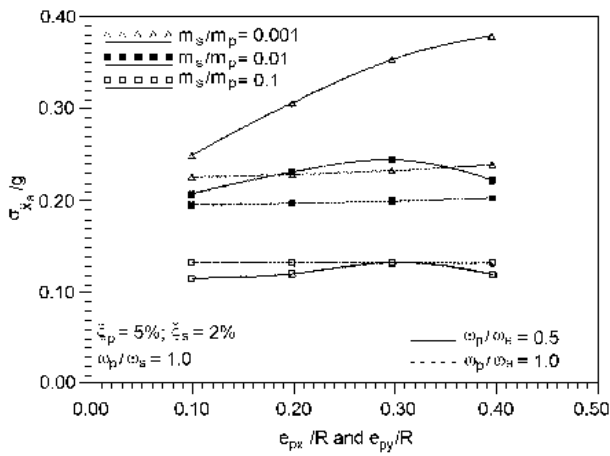

Figure 6. Variation of $(\sigma_{\bar{x}_a} / g)$ with m_s / m_p for $\omega_p / \omega_s = 1.0$.

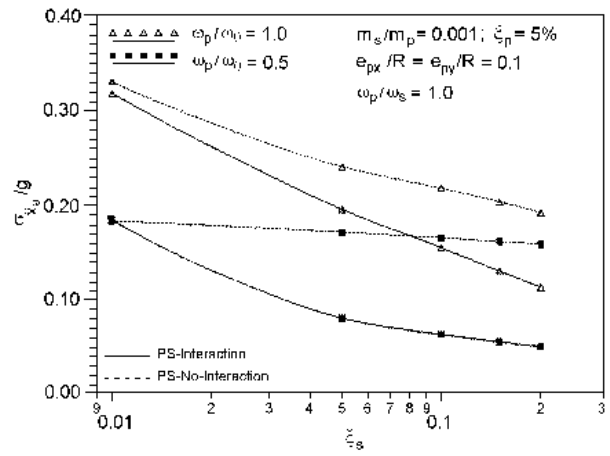

Figure 8. Variation of $(\sigma_{\bar{x}_a} / g)$ with ξ_s for $\omega_p / \omega_s = 1.0$.

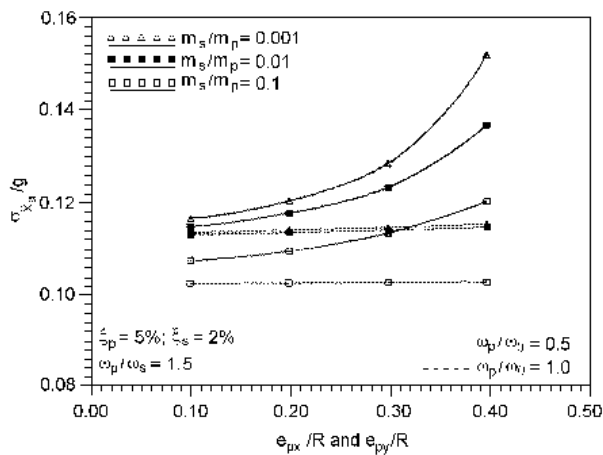

Figure 7. Variation of (σ_M) with m_s / m_p for $\omega_p / \omega_s = 1.0$.

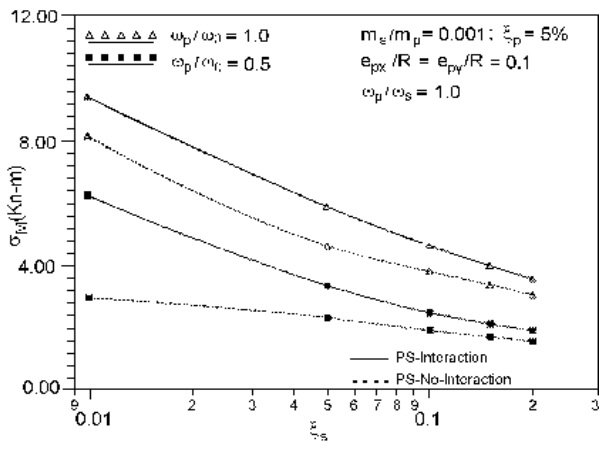

Figure 9. Variation of (σ_M) with ξ_s for $\omega_p / \omega_s = 1.0$.

tuned condition, the variation of the response with e_{px} / R and e_{py} / R shows a definite maximum for higher mass ratios ($m_s / m_p = 0.01$ and 0.1). For the untuned condition, however, no such peaks in the response are observed, and the response increases non-linearly with the increase in e_{px} / R and e_{py} / R .

For the strong torsionally coupled P-system, the variation of the $(\sigma_{\bar{x}_a} / g)$ is insensitive to the variation in e_{px} / R and e_{py} / R , for both tuned and untuned conditions. Further, it may be noted that the response is more for smaller values of the m_s / m_p ratio.

6.4. Effect of ξ_s

The variations of $(\sigma_{\bar{x}_a} / g)$ and (σ_M) with ξ_s are shown in the Figures (8) and (9) under the tuned condition. For the strong torsionally coupled P-system the responses decrease with the increase in ξ_s , when interaction is considered between the PS-system. For the weak torsionally coupled P-system, the responses are insensitive to the change in the ξ_s , if interaction is not considered between the PS-system. However, for no-interaction case the responses decrease with the increase in ξ_s , for the strong torsionally coupled P-system.

6.5. Effect of Angle of Orientation of the S-system with X-X Axis

The variations of responses with the angle of orientation (θ) of the S-system with the X-X axis are shown in Figures (10) to (13), for strong and weak torsionally coupled P-system under both tuned and untuned conditions, and for both interaction and no-interaction cases. Under the tuned condition, variation of the $(\sigma_{\bar{x}_a} / g)$ shows a definite minimum when interaction is not considered between the PS-system, see Figures (10) to (12), for both strong and weak torsionally coupled P-system. For all other cases, the variations show definite maxima. The values of the maximum and minimum responses occur around an angle of 45° , as it would be expected.

7. Conclusions

Seismic behavior of multisupport secondary structural system mounted over a torsionally coupled linear primary structural system has been investigated by considering and ignoring the interaction between the primary and the secondary systems. The primary structural system is subjected to bi-directional ground excitation which is

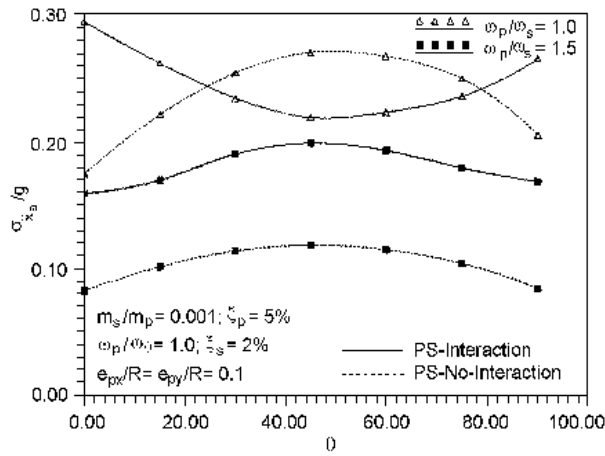

Figure 10. Variation of (σ_{x_a} / g) with θ for 1.0.

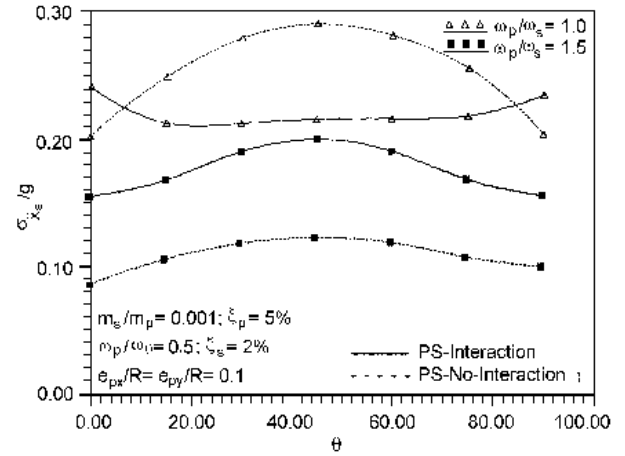

Figure 12. Variation of (σ_{x_a} / g) with θ for 0.5.

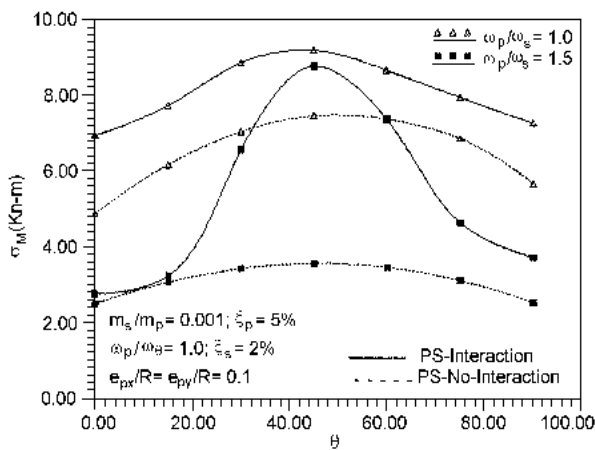

Figure 11. Variation of (σ_M) with θ for 1.0.

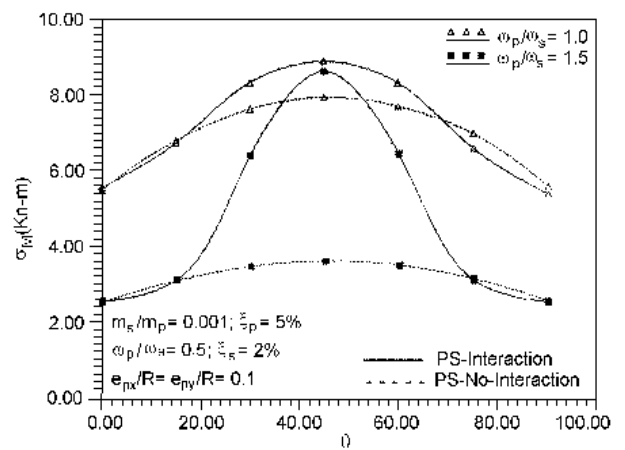

Figure 13. Variation of (σ_M) with θ for 0.5.

modelled as a white noise. The response quantities of interest are the standard deviation of bending moment at a specified support and the normalized acceleration at a specified node of the multiple supported S-system. The responses are obtained by frequency domain spectral analysis. The findings of the parametric studies lead to the following conclusions:

- ❖ Responses of the S-system decrease with the increase in e_{px} / R and e_{py} / R ratio, for strong torsionally coupled P-system, under both tuned and untuned conditions. For other cases, responses are either insensitive to or increase with the increase in e_{px} / R and e_{py} / R ratio.
- ❖ For strong torsionally coupled P-system under both tuned and untuned conditions, the responses are more if interaction is considered between the PS-system.
- ❖ For weak torsionally coupled P-system the responses are found to be more if interaction is not considered between the PS-system.
- ❖ For all cases, the tuned condition gives higher responses as compared to the untuned condition.
- ❖ The responses of the S-system decrease with the

increase in the m_s / m_p ratio. For weak torsionally coupled P-system, the variation of responses with e_{px} / R and e_{py} / R show a definite maximum for the higher m_s / m_p ratio under the tuned condition.

- ❖ The responses of the S-system generally decrease with the increase in ξ_s .
- ❖ For strong and weak torsionally coupled linear P-system under the tuned condition, the normalized acceleration of the S-system is found to be minimum if orientation of the S-system is 45° with the X-Xaxis when interaction between the primary and the secondary systems is considered. For all other cases, the response quantities are found to be maximum for the above orientation of the S-system.

References

1. Kiureghian, D.A., Sackman J.L., and Omid, B.N. (1983). "Dynamic Analysis of Light Equipment in Structure: Response to Stochastic Input", *Journal of Engineering Mechanics*, ASCE 90-110.

2. Lin, J. and Manhin, A. (1985). "Seismic Response of Light Subsystems on Inelastic Structures", *Journal of Structural Engineering, ASCE*, **2**, 400-417.
3. Chen, Y. and Soong, T.T. (1988). "State-of-the-art Review: Seismic Response of Secondary Systems", *Engineering Structures*, **10**, 218-228.
4. Jangid, R.S. and Datta, T.K. (1993). "Spectral Analysis of Systems with Non-Classical Damping Using Classical Mode Superposition Technique", *Earthquake Engineering and Structural Dynamics*, **14**, 723-735
5. Suarez, L.E. and Singh, M.P. (1987). "Eigenproperties of Non-Classically Damped Primary Structure and Equipment System by a Perturbation Approach", *Earthquake Engineering and Structural Dynamics*, **15**, 565-583.
6. Kelly, J.M. and Sackman, J.L. (1978). "Response Spectra Design Methods for Tuned Equipment-Structure Systems", *Journal of Sound and Vibration*, **59**(2), 171-179.
7. Gupta, A.K. and Jaw, J.W. (1986). "Response Spectra Method for Nonclassically Damped Systems", *Nuclear Engineering Design*, **91**, 161-169.
8. Singh, M.P. (1980). "Seismic Design Input for Secondary Systems", *Journal of Structural Division, ASCE*, **106**, 505-517.
9. Suarez, L.E. and Singh, M.P. (1987). "Floor Response Spectra with Structure-equipment Interaction Effects by Mode Synthesis Approach", *Earthquake Engineering and Structural Dynamics*, **15**, 151-158.
10. Kelly, J.M. and Sackman, J.L. (1997). "Equipment-Structure Interaction at High Frequencies", Weidlinger Associate, Menlo Park CA, Report No. DNA 42981.
11. Igusa, T. and Kiureghian, A.D. (1985). "Generation of Floor Response Spectra Including Oscillator-Structure Interaction", *Earthquake Engineering and Structural Dynamics*, **13**, 661-676.
12. Asfura, A. and Kiurghian, A.D. (1984). "A New Floor Response Spectrum Method for Seismic Analysis of Multiply Supported Secondary Systems", Earthquake Engineering Research Center, University of California, Report No. UBC/EERC-84/04.
13. Singh, M.P. (1980). "Seismic Response by SRSS for Nonproportional Damping", *Journal of the Engineering Mechanics Division, ASCE*, 1405-1419.
14. Singh, M.P. and Burdisso, R.A. (1987). "Multiply Supported Secondary System Part II: Response Spectrum Analysis", *Earthquake Engineering and Structural Dynamics*, **7**, 37-90.
15. Burdisso, R.A. and Singh, M.P. (1987). "Multiply Supported Secondary System Part I: Response Spectrum Analysis", *Earthquake Engineering and Structural Dynamics*, **7**, 53-72.
16. Muscolino, G. (1990). "Dynamic Response of Multi-Connected Primary-secondary Systems", *Earthquake Engineering and Structural Dynamics*, **19**, 205-216.
17. Fasone, G., Muscolino, G., and Ricciardi, G. (1991). "Combined Dynamic Response of Primary and Multiply Connected Cascaded Secondary Sub-Systems", *Earthquake Engineering and Structural Dynamics*, **12**, 749-767.
18. Yang, Y.B. and Huang, W.H. (1993). "Seismic Response of Light Equipment in Torsional Buildings", *Earthquake Engineering and Structural Dynamics*, **22**, 113-128.
19. Yang, Y.B. and Huang, W.H. (1998). "Equipment Structure Interaction Considering the Effect of Torsion and Base Isolation", *Earthquake Engineering and Structural Dynamics*, **27**, 155-171.
20. Kan, C.L. and Chopra, A.K. (1997). "Effects of Torsional Coupling on Earthquake Forces in Buildings", *Journal of Structural Division, ASCE*, **103**, 805-819.
21. Agrawal, A.K. and Datta, T.K. (1997). "Behavior of Secondary System on Torsionally Coupled Primary System", *European Earthquake Engineering*, **2**, 47-53.
22. Agrawal, A.K. and Datta, T.K. (1998). "Nonlinear Response of Secondary System Due to Yielding of Torsionally Coupled Primary System", *European Earthquake Engineering*, **2**(3), 339-356.
23. Gasparini, D.A., Shah, A., Tsia, T.G., Shein, S.L., and Sun, W.T. (1983). "Random Vibration of Cascaded Secondary Systems", Report 83-1-Jan. Case Institute of Technology, Cleveland, Ohio.
24. Paz, M. (1991). "Structural Dynamics Theory and Computation", Third Edition, Van Nostrand Reinhold, New York.
25. Clough, R.W. and Penzien, J. (1993). "Dynamics of Structures", McGraw-Hill, New York.